



MESCAL

SKYWALK

MANUAL/SERVICE

SerialNo:

CONTENT

1	Introduction	Page 39
2	Description	Page 40
3	Line System	Page 41
4	Technical Data	Page 43
5	Acceleration System	Page 44
6	Harness	Page 45
7	Flight Techniques	Page 46
8	Descent Techniques	Page 52
9	Extreme Flight Manoeuvres	Page 56
10	Materials	Page 60
11	Maintenance	Page 61
12	2-Year-Check	Page 63
13	Certification	Page 63
14	Nature and Ecological Compatibility	Page 64
15	Closing words	Page 64
16	Line Plans	Page 65
17	Risers	Page 66
18	Test Protocols	Page 70

1 INTRODUCTION

Thank you for choosing a skywalk Paraglider! We are sure that your trust will be rewarded with many hours of flying pleasure. So that you will feel comfortable with your glider from the very beginning, we recommend that you read this manual carefully. This way you can thoroughly and quickly acquaint yourself with your skywalk MESCAL3.

This operating manual will give you tips for safe and confident flight, so that you will enjoy many flying hours with your MESCAL3. For helpful suggestions, questions or critic, please call or send us an e-mail. We are gladly at your disposal.

THE SKYWALK TEAM



2 DESCRIPTION

The skywalk model range MESCAL stands for a symbiosis of safetiness, performance and handling. JET FLAP Technology has consequently become widely acknowledged and accepted in the past few years and so the -MESCAL 3 is also equipped with a further developed slotted flap. Alongside the best climb performance, JET FLAPs guarantee very low landing speeds and high safety potential. This Technology is standard at Skywalk gliders since years now and even high performance wings like in the POISON series has it.

Basis for Mescal 3 is the extremely safe and proven Tequila 2 concept. Target was to reach the high standard LTF 09 and EN : A certification.

Therefore we had to change profile, tension and Ballooning of the glider. This was the way to go to get a good schoolglider with a nice handling. The Mescal 3 is a perfect partner for the beginner pilot during education but also for the time afterwards to improve pilots level with a lot of fun. Mescal 3 has 44 cells and only 12 attachmentpoints per half glider which reduces drag, therefore increases performance. In all cells, diagonal and compression bands provide for optimum load distribution.

An intricate distribution of tension inside and along the canopy increases stability and eliminates undesired deformations.

The outside wing was designed to carry less load in order to achieve an even and predictable feel in turns. Large cross-ports in the profile ribs provide for an effective inflation of all cells, without compromising profile accuracy.

Velcro bands are attached to the outer wings, in order to facilitate the emptying of sand from the glider.

3 LINE SYSTEM

The lines of the MESCAL3 show high stability at a very small diameter, thanks to extensive testing. The control of the lines, as well as the effective use of the accelerator was a priority issue for us.

All of our reflections and calculations have safety at the forefront. This is why we have chosen the TECNORA TSL Material from Liros for the main lines, as well as Liros New Dyneema for brakes, middle and the topline.

The skywalk MESCAL3 has 3 A-, 3 B-, 3 C, 2 D-main lines as well as 1 Stabiliser line. The last cell has a A and B Top line which together with the stabiliser top line, are joined at the stabiliser main line. These go directly to the C-Riser.

The Brake Lines are non-carrying and lead from the back of the canopy (trailing edge) over the main brake line through the pulley on the D-Riser to the brake handles. There is a mark on the main brake line indicating the position of the handle attachment. This adjustment mustn't be altered in order to provide enough brake feedback for landing and in extreme flight situations yet enough slack not to continuously brake the glider in normal flight.

For better identification purposes, the A-Lines and A-risers are red, and the stabiliser is pink. The B-lines, and brake lines are yellow and all other lines are blue. The line maillons are triangular and have a rubber grommet to prevent the looped lines from slipping.

The skywalk MESCAL3 has five risers on each side. The two inner A-main lines are attached to the front A-Riser, the outer A-main line attaches to the second A-Riser.

- > The B-main lines lead to the B-Riser.
- > The C-main lines and the stabiliser line lead to the C-Riser.
- > The D-main lines lead to the D-Riser.

Riser Illustration page 66-68.

IMPORTANT SAFETY WARNING

FLYING A PARAGLIDER REQUIRES MAXIMUM CAUTION AT ALL TIMES. BE AWARE THAT FLYING A PARAGLIDER IS ALWAYS DONE AT YOUR OWN RISK. AS A PILOT YOU HAVE TO GUARANTEE THE FLYING CAPABILITY OF YOUR PARAGLIDER BEFORE EVERY SINGLE FLIGHT.

Don't use your skywalk MESCAL3:

- > Outside the certified take-off weight.
- > With any engine, except if there is a certification from the DULV or EAPR.
- > In rainy, snowy and extremely turbulent weather conditions or high winds.
- > In fog or clouds.
- > With insufficient experience or training.

Every pilot is responsible for his own safety and will have to ensure that his aircraft (paraglider) has been checked and serviced for its airworthiness before flying.

You can only fly your skywalk MESCAL3 with a valid flying license and in accordance with local rules and regulations.

During its production your skywalk MESCAL3 has passed thorough quality controls. More spot checks were performed before its delivery.

4 TECHNICAL DATA

TYP	XS	S	M	L	XL
Number of cells	44	44	44	44	44
Area [qm]	22,57	24,76	27,06	29,36	32,24
Wingspan [m]	10,66	11,16	11,67	12,16	12,74
Aspect Ratio	5,03	5,03	5,03	5,03	5,03
Area projected[qm]	19,6	21,7	23,5	25,5	28
Wingspan projected [m]	8,55	9	9,37	9,76	10,22
Aspect ratio projected	3,73	3,73	3,73	3,73	3,73
average line length* [cm]	620	653	680	707	740
line diameter [mm]			1/1,2/1,8		
cord max. [cm]	263	277	289	300	315
cord min. [cm]	60	63	66	69	78
canopy weight [kg]	4,8	5,3	5,8	6,3	6,9
take-off weight* [kg]	60-80	75-95	85-105	100-120	115-140
Pilot + 17 kg equipment					

This paraglider meets the demands of the regulations of german hanggliding association LTF 09, or the EN Norm 926-2:2005. At both certifications Mescal 3 reached the A class.

Further details of the construction and the measurements are described in the type sheet of the respective homologation association, which is part of this manual. The measurements of the line elements are listed in the type sheet or in the lineplans. The DHV measures with 5 kg weight from the line carabiner to the bottom sail.

5 ACCELERATION SYSTEM

The skywalk MESCAL3 can be equipped with a foot-operated Acceleration-System.

ATTENTION:

THE DHV RATING OF SOME GLIDER SIZES CAN CHANGE DURING THE USE OF THE ACCELERATION SYSTEM IN FLIGHT. TO DETERMINE WHICH SIZES ARE AFFECTED PLEASE CHECK THE TYPE SHEET.

The Acceleration-system effects the A-, B- und C-Risers. Originally, all the Risers have the same length.

During full operation of the acceleration-system, the A-, B- and C-Riser is shortened in a certain ratio. The D-Riser retains its original length.

This way the perfect shape of the canopy is maintained even during accelerated flight. See exact riser drawings on page 66-68.

Installing the accelerator equipment:

Most commonly used harnesses have pulleys for the acceleration-system already attached. The acceleration line runs from the front through the pulleys at the harness to the top. They are tied to the "Brummel-hooks" at the right length.

With the right adjustment of the acceleration lines, the foot-bar can be reached easily with angled legs during flight. By straightening the legs, the whole acceleration range can be used.

Prior to flying, the connection hooks of the footoperated accelerator and the acceleration-system have to be connected to each other (Brummel-hooks). Check that the acceleration line runs freely.



Function:

By using the foot-operated accelerator the pilot reduces the force via a pulley-system by half and shortens the A-, B- and C- risers.

Accelerated risers illustrated on page 66-68.

6 HARNESS

The skywalk MESCAL3 is licensed for all certified harnesses of the GH type (harnesses without solid cross-bracing). Be aware that the level of suspension changes the relative braking distance.

CAUTION:

FULLY CROSS-BRACED HARNESSES EFFECT THE HANDLING DRASTICALLY AND DO NOT LEAD TO HIGHER SAFETY!



7 FLIGHT TECHNIQUES AND CHARACTERISTICS

PREFLIGHT CHECK AND MAINTENANCE

It is important to check all paragliding equipment thoroughly before every flight to see if it has any defects. Also check the paraglider after long flights and after long storage.

CHECK THOROUGHLY:

- > All seams of the harness, of the risers and of the reserve bridle.
- > That all connecting parts, maillons and carabiners are closed.
- > The brake-line knots on both sides and follow the brake-line to the top.
- > All the other lines from riser to canopy.
- > All the line attachment points at the canopy.
- > If the top or bottom of the wing are damaged or perished.
- > The ribs and crossports from inside.

DO NOT TAKE-OFF IF YOU DETECT ANY DEFECTS, EVEN IF THEY ARE MINOR!

If you find any damage or excessive wear and tear please get in touch with your flying school.

LAYING OUT THE GLIDER:

If you use your paraglider for the first time we recommend that you practise some inflations and try some simple flights at a training site. This way you are able to get used to your skywalk MESCAL3.

Lay out the canopy so that the leading edge is slightly arched. The middle of the canopy should form the deepest point of the paraglider. This way the A-lines are tensioned first in the middle whilst inflating. The paraglider inflates evenly which ensures a stable and straight take off.

Separate A, B, C, D-lines and risers and put in order. Make sure that the brake lines run freely through the pulleys to the trailing edge of the paraglider.

All lines have to run freely without any knots and twists from the risers to the canopy.

During flight, tied or crossed over lines can often not be released or untangled!

The brake-lines are lying directly on the ground, so please pay attention that they do not become entangled during launch. There shouldn't be any lines beneath the canopy during take-off. Line-overs can have fatal consequences!

TAKE-OFF

The skywalk MESCAL3 is very easy to launch.

Hold the two A-risers and the brake handles in your hands. For a better identification, the A-lines and covers at the A-risers are coloured red. The brake lines are coloured yellow and the brake handles are black.

Hold your arms slightly sideways and backwards like an extension of the A-risers.

Before launching check the laid out glider. Further check the wind direction and the airspace! Pull rapidly and the canopy of the skywalk MESCAL3 will launch and rise above your head. The canopy will inflate fast and reliably.

Keep the paraglider straight above your head and run forward. Slow down a little as soon as the upward pull decreases. You can open any collapsed cells by pumping the affected side. Changes of directions that are necessary can be carried out now. Look and feel that the wing is properly inflated.

Don't make your final decision to accelerate or to take-off until you are absolutely sure that the wing is properly and evenly inflated. Otherwise, stop the take-off procedure immediately!

During reverse launches and in strong winds, it is possible that the paraglider surges forward and inflates faster than intended. You can counteract this by running towards the glider. We recommend practicing this demanding launch technique on a flat slope! If you reverse launch it is advisable to only use the inside A-risers. This way the glider opens a bit more slowly and in strong winds you don't have to deal with the full pressure at once.

The MESCAL3 is also equipped with the innovative JET FLAP System.

Air is conducted from the bottom sail (pressure area) to the top sail (low-pressure area) and is blown out there with higher speed. The connection is established through jet shaped channels, which are located in the rear section of the wing.

When increasing the angle-of-attack the danger of airflow interruption and subsequent stall is minimized.

Results: the constant airflow even at great angles-of-attack delays the stall, the flyable minimum speed is lowered and the pilot has a higher incidence range. This is of great importance, especially during take-off and landing. Of course, the JET FLAPS are no reason for uncontrolled braking, but the slow flight characteristics of the MESCAL3 profit immensely. You don't need any special knowledge to have control of the flap-system, the use of a JET FLAP paraglider is the same as a conventional glider.

In the general aviation it is standard to use checklists before you take-off. We would like to help you with some pictograms on the A-riser not to forget anything while you make your take-off check:

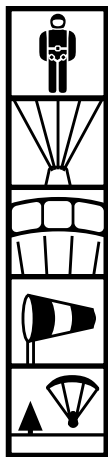

• **1: CHECKLIST PILOT:**

Legstrap buckles, chute/harness main Carabiner, harness, helmet.

• **2: CHECKLIST WING LINES/HARNESS:**

lines free, brake lines free and not twisted, Harness correctly attached.

• **3: CHECKLIST PARAWING:**

Wing stretched out and free, leading edge air ducts open, pilot standing in the middle.

• **4: WIND CHECK:**

How strong? Which direction?

• **5: AIRSPACE CHECK:**

My take-off should not hinder any other pilots start or airspace.

TURNING

The skywalk MESCAL3 is very manoeuvrable and reacts to steering inputs directly and without delay. Simple weight shift enables you to fly very flat turns with minimal altitude loss. Combined steering technique: Weight shifting and pulling of the inside brake line allow extra tight turns. During turning you can control the speed, the curve radius and banking by additional use of the outer brake. Counter braking or releasing the brake lines can change these parameters most effectively.

CAUTION:

PULLING THE BRAKE LINES TOO FAR AND TOO FAST CAN CAUSE A FULLSTALL!

You will recognise a flat spin through high steering pressure and a slight backwards folding of the outer wing section. If this happens you have to release the inside brake immediately.

EMERGENCY STEERING:

In case one or both brake lines break you are able to steer and land the skywalk MESCAL3 with the aid of the D-risers.

ACTIVE FLYING:

Active flying means flying in harmony with your Paraglider. Anticipate the behaviour of your skywalk MESCAL3 in flight, especially in turbulent and thermal conditions and react accordingly. In calm air necessary corrections will be minimal, but turbulence demands permanent attention and the use of brakes and weight shifting with the harness.

Good pilots have instinctive reactions. It is important that you always have direct contact to the canopy by slight pressure on the brakes in order to feel the stored energy of the glider. This way you will recognise a loss of pressure in your canopy and subsequent collapse early and are able to react in time. MESCAL3 is featured with a profile that dampens turbulences. This provides high resistance against collapses, however it can happen without a pilots reaction.

EXAMPLES:

When flying into strong thermals, you have to release the brakes. When flying into falling airstream, pull the brakes. This way you can avoid extensive changes in the angle of attack.

In turbulent air, you feel the release in pressure on parts of the glider through the feedback from your brakes. You can balance this by quickly pulling the brake a little more until the pressure returns. Always apply brakes softly and progressively. Don't slow down your glider too fast as this can increase the danger of stalling!

By active flying you can avoid almost all deformations of the glider in advance.

ACCELERATED FLYING:

To use the acceleration-system you will need to make some effort. This can affect the sitting position in the harness. Therefore we recommend an upright position in the harness. Adjust the harness before your first attempt of accelerated flight.

We remind you to only fly in wind conditions that don't require constant use of the acceleration-system.

To reach the maximum speed press the acceleration-system firmly until both pulleys on the A-risers touch each other. As soon as you apply the acceleration-system the angle of attack will be reduced, the speed increases, but the paraglider becomes less stable and can collapse more easily. Therefore always use the acceleration-system with adequate altitude from the ground, obstacles and other aircraft.

Avoid flying with too short brake lines. Accelerated collapses are normally more impulsive and demand fast reactions.

NEVER ACCELERATE IN TURBULENT AIR!
NEVER ACCELERATE NEAR THE GROUND
NEVER LET GO OF THE BRAKE HANDLES!

In case the glider collapses you will have to release the acceleration-system immediately to stabilise and reopen your paraglider.

LANDING:

The skywalk MESCAL3 can be landed easily. Make your final approach against the wind and let the glider slow down at its own rate. Further reduce the speed by applying the brakes lightly and evenly. At about 1m above the ground you increase the angle of attack by slowing down more and eventually completely flare out the glider. When you have reached the minimal speed apply full brake. In strong head winds, slow down carefully. When you have reached the ground safely, stall the glider warily. Avoid turning sharply before your final approach. This increases the danger of pendulum effect!

WINCHTOWING:

The skywalk MESCAL3 is very suitable for winchtowing. Make sure you climb from the ground at a flat angle.

- > Pilot must be instructed in towing.
- > Pilot must use a certified winch.
- > Winch driver must be instructed in towing. When towing please steer carefully, do not over-brake, the glider will fly with an increased angle of approach.

MOTORISED FLIGHT:

You can inform yourself about the current status of certification of motorised flight at your dealer, national distributor or directly through us. At this time (March 2011) we don't have a license.

CAREFULLY PACKING YOUR PARAGLIDER WIL INCREASE ITS LONGEVITY.

- > Empty the glider from all debris such as leaves, twigs, grass, sand etc.
- > Sort out your lines and spread them evenly on the glider.
- > Make sure the glider is dry when storing it for a longer period of time.
- > Fold the glider starting in the middle and working your way to the outside always folding 2 cells, so that the leading edge is folded cleanly.
- > Fold the cells, starting from the second cell from the middle, so that the reinforced edges of the cell openings are on top of each other, do the same at the lower long-edge of the glider. This folding method is best done together with a friend, but you should be able to do the same on your own after some practice.
- > Then press the air out of the folded glider starting at the bottom and working your way to the top.
- > Fold the whole row once toward the middle, do exactly the same on the other side.
- > Then fold one half onto the other half and make sure the leading edge are folded cleanly.
- > Start wrapping up the glider from its lower end. The wraps should be approx. 1ft. wide.
- > The leading edge can be folded inwards once, but is not necessary.
- > The left over air should be pressed out of the glider and not through the material (this can increase the porosity of your glider).
- > Now attach the compression band around the packed wing, at right angles to the cell openings, then slide the glider into the light nylon bag.
- > This helps to protect the cloth from being damaged by sharp edges or zippers from your harness.
- > Open the backpack and place your glider on the inside edge.
- > The soft wing on your back will make transportation much more comfortable.
- > Place the harness with the seat board facing up on top of your glider and close the zippers.
- > Put the rest of your equipment (helmet, overall, instruments etc.) under the hood of your backpack.

DESCENT TECHNIQUES

The MESCAL3 manual is not a textbook for learning how to paraglide. According to the local rules and regulations, instruction and training must be carried out in licensed schools. The following information enables you to get the most out of your skywalk MESCAL3.

SPIRAL DIVE:

You can initiate the spiral dive by carefully increasing the pull on one of the brakes and simultaneously shifting your weight to the inside of the turn. If the glider doesn't bank up and the sink rate doesn't increase, then try again. Don't just apply more and more brake without sensitivity.

The skywalk MESCAL3 enters the spiral dive with a high bank angle and makes a fast steep turn. The banking and sinking can be controlled by dosed pulling resp. loosening the inner brakeline. Smooth braking of the outer wingtip not only helps to avoid collapses, the pilot is also more easily able to control the rate of sink.

The spiral is the most effective tool in losing altitude. This is advantage and disadvantage at the same time, the pilot needs to be able to handle the resulting high sink rates.

CAUTION:

THE HIGH SINK RATE CAUSES HIGH PHYSICAL STRAIN DUE TO THE INCREASING CENTRIFUGAL FORCES AND MAY CAUSE BLACKOUTS!

Tensing the stomach muscles during the spiral dive can be helpful. At the first signs of dizziness or feeling faint exit the spiral dive immediately.

Because of the extreme loss of altitude experienced during a spiral dive always ensure you have enough altitude above ground.

To avoid a strong surge when exiting the spiral dive you have to release the inside brake while applying the outer brake slightly.

The skywalk MESCAL3 has no tendency for locking into a spiral dive. In case it keeps turning under unfavourable circumstances (e.g. unintended asymmetry of the cross brace harness) you will have to actively finish the spiral dive. In this case shift your weight to the outside of the turn and simultaneously apply more outside brake. Applying both brakes will also take the paraglider out of the spiral dive but the glider can front tuck and you should dampen the exit with the brakes.

Remember: Compared to regular flight manoeuvres the steering forces in a spiral dive are a lot higher!

B-LINE STALL:

The B-lines are pulled down symmetrically (20cm). Keep the brake handles in the respective hands. The airflow on top of the profile largely detaches and the paraglider descends without flying forward. By pulling the B-lines stronger the canopy surface decreases and the descent increases. You can exit the stall by quick and symmetric release of the B-lines. The paraglider will pitch forward and pick up speed. At no time you may use the brakes in this case! You must exit the B-line stall immediately if the canopy starts to form a forward facing semi-circle. If the wing doesn't reopen you may speed up the opening process by gently braking.

BIG EARS:

In contrast to the spiral dive and B-line stall, Big Ears result in an increase of forward speed in relation to the gliders sink rate. Big Ears is used to avoid or exit dangerous areas in a horizontal direction.

EXAMPLES:

- > In strong winds or below a thundercloud it is possible that neither B-line stall or spiral dive will help.
- > Big Ears are the easy way out, if the pilot is stuck in strong lift and needs to look for sink, it is advisable to exit the lift band with the use of Big Ears.
- > To fold the outer wingtip you only need to pull the outer A-lines symmetrically. In doing so it make sense to grab the lines as far up as possible for folding maximum area.
- > The skywalk MESCAL3 will enter now a stable sink flight.

- > The brake handles remain in your hands together with the outer A-risers. Braking and weight shift enables you to steer your paraglider.
- > In order to increase the sink and forward speed you can optimise this manoeuvre by using the acceleration-system.
- > The risk of canopy destabilisation in turbulent air is clearly reduced when using Big Ears.
- > To exit Big Ears release the A-lines. The canopy will unfold automatically. You may brake a little to support the unfolding.
- > It is advisable to pump out one side at a time to reduce the risk of detaching airflow.



CAUTION:

ALL DESCENT TECHNIQUES SHOULD BE TRAINED IN CALM AIR AND WITH SUFFICIENT ALTITUDE BEFORE USING THEM IN EMERGENCY SITUATIONS AND IN TURBULENT AIR.

Any extreme flight manoeuvre and descent technique demands:

- > Training, either with an instructor in a paragliding school or during a safety training course.
- > Double-checking that before entering a manoeuvre you have sufficient altitude and clear air space below.
- > Permanent visual contact with the canopy.



9 EXTREME FLIGHT MANOEUVERS

ASYMETRIC TUCK:

In strong turbulence, the canopy may collapse. The skywalk MESCAL3 will re-open automatically even after bigger collapses within a turn of 180°. The turning towards the collapsed wing section can be minimised by braking on the remaining open side of the canopy. In case of a big collapse you will have to brake with caution in order to avoid a stall. In case the canopy still doesn't recover you can accelerate the opening process by pumping the brake on the tucked side.

CRAVAT/LINE OVER:

This type of instability never occurred during any of our test flights with the skywalk MESCAL3. Still, in extremely turbulent air or during exceptional piloting errors it is possible that the folded wing section might get tangled in the lines. The pilot may then stabilise the paraglider by careful counter-braking. Without immediate intervention of the pilot a cravated paraglider will turn into a strong spiral dive.

There are several possibilities to untangle the paraglider:

- > Pumping on the folded side.
- > Pulling the stabiliser-lines (tip-lines).

In case none of these manoeuvres have any success you can try to unfold the paraglider by performing a Fullstall. Only experienced pilots, with a lot of flight experience should attempt this maneuver. Make sure you have enough altitude to recover the Fullstall in time.

IF NONE OF THESE MANOEUVERS ARE SUCCESSFUL OR THE PILOT FEELS OVERWHELMED BY THE SITUATION THE RESERVE PARACHUTE SHOULD BE DEPLOYED IMMEDIATELY!

FRONT TUCK:

The paraglider can be front tucked by a strong pull on the A-risers or when encountering strong sink. The leading edge will fold forward along the whole length of the wing. Light braking will reduce the forward surge and will help to speed up the opening of the canopy. The skywalk MESCAL3 will normally recover from a Front Tuck automatically and without pilot input.

THE PARACHUTAL STALL:

The paraglider has no forward speed and a greatly increased descent rate. The Parachutal Stall may follow a too passively released B-line Stall. Porous canopy fabric (excessive UV-degradation) or frequent, strong towing (stretched A-lines) results in an increased risk of a Parachutal Stall. The pilot can recover from the Parachutal Stall by slightly pushing the A-risers forward at the mallions or by using the accelerator. The skywalk MESCAL3 usually exits the Parachutal Stall automatically.

CAUTION:

**AS SOON AS YOU APPLY THE BRAKES DURING A PARACHUTAL STALL THE PARAGLIDER WILL IMMEDIATELY ENTER A FULLSTALL.
IF STILL IN A PARACHUTAL STALL CLOSE TO THE GROUND DO NOT ATTEMPT TO RECOVER BUT STRAIGHTEN UP YOUR POSITION IN THE HARNESS AND PREPARE FOR A PARACHUTE LANDING ROLL.**



FULLSTALL:

In order to Fullstall your paraglider take a wrap on both brake handles and pull strongly and symmetrically until the airflow breaks away from the canopy.

The canopy will drop backwards. Despite this violent reaction keep the brakes fully depressed until the canopy stabilises above your head.

In a Fullstall the skywalk MESCAL3 flies backwards but doesn't always form a forward facing semi-circle. This semi-circle can be achieved by a slower entry into the Fullstall.

In order to exit a Fullstall the pilot will have to release the brakes slowly and symmetrically (Recovery time ≥ 1 sec).

The glider opens and surges forward to pick up speed. Brake gently to dampen the forward surge of the skywalk MESCAL3 and to counteract a possible Front Tuck.

CAUTION:

IN CASE THE FULLSTALL IS RELEASED TOO EARLY, TOO FAST OR WITH THE WRONG TECHNIQUE THE CANOPY MAY SHOOT FORWARD STRONGLY!



NEGATIVE SPINS:

A paraglider spins negative if the airflow disconnects over one half of the wing. The canopy turns around the vertical axis and the turnpoint is inside the gilder. The inner part of the wing is in a reverse flight.

There are two reasons for the Negative Spin:

- > One brake is pulled too far and too hard (e.g. when entering a spiral dive)
- > One brake is pulled too hard when flying slow (e.g. in thermal flying).

The skywalk MESCAL3 usually re-enters normal flight immediately after the brake is released without any great altitude loss. Simply release the excessively induced brake until the airflow re-connects to the inside wing.

After a long lasting spin it is possible that when releasing the brake the canopy might shoot forward and collapse. Cross-braced harnesses that are too narrow increase the tendency to spin on most paragliders.

WINGOVER:

Alternating left/right turns lead to an increased banking of the canopy. The load on the outside wing tip to a minimum (the tip starts to feel light). Further turns and higher banking is not recommended at this stage as the canopy might collapse on the inside wing section.

CAUTION:

FULLSTALL, NEGATIVE SPIN AND WINGOVERS (ABOVE 90°) ARE ILLEGAL ACROBATIC FLIGHT MANOEUVERS AND ARE NOT PERMITTED IN REGULAR AIR TRAFFIC. WRONG OR EXCESSIVE STEERING IN THESE SITUATIONS MAY HAVE FATAL CONSEQUENCES INDEPENDENT OF THE TYPE OF PARAGLIDER USED!

10 MATERIALS

The skywalk MESCAL3 is manufactured out of highest-grade materials. skywalk has chosen the best possible combination of materials in respect to durability, performance and longevity. We know that durability is a deciding factor for the customer's satisfaction.

WING AND RIBS:

Top Sail	Porcher Marine Nylon 9092E85A, 9017E68A
Bottom Sail	Skywalk TSF-SC 39
Ribs and Compression Bands	Porcher Marine 9017E29A, TSF SC39 Nylon
Leading edge reinforcements	Dacron
Attachment point reinforcements	Dacron

LINES:

LIROS has been the world's leading producer of paragliding lines for quite some time. We chose the TSL lines because of their minimum stretch and the high consistency in length.

Top- and Brakelines	DSL 70 and PPSL 120
A-, B- and C-Mainlines	TSL280 and NTSL 160
D- and Stabilo Mainlines	NTSL 160
Main-Brakelines	DFLP200/32

RISERS:

The risers are manufactured from 25 mm Polyester webbing by Güth und Wolf. Stretch values, strength and stability of this material are among the highest of all webbing products currently on the market.

11 MAINTENANCE

With proper maintenance, your skywalk MESCAL3 will be in an airworthy condition for several years. A well cared-for paraglider lasts a lot longer than one which is packed in its bag carelessly after use.

Always remember: Your life depends on your paraglider!

STORAGE:

Store your paraglider in a dry location, protected from light and away from chemicals! Dampness is a natural enemy for any paraglider. Therefore, always make sure your paragliding equipment is dry before packing it away. Dry if necessary in a heated room.

CLEANING:

Rubbing and cleaning leads to faster deterioration of your paraglider. The PU-coated canopy fabric of the skywalk MESCAL3 protects it well from pollution. If you still think that your paraglider needs to be cleaned, then use a soft and wet towel or sponge. Don't use any soap or detergents. Never use flammable products.

REPAIR:

All repairs must be carried out by the manufacturer or by an authorised skywalk-Service-Centre. Amateur repairs can cause more harm than good.

DISPOSAL:

skywalk places high value on the environmental compatibility and quality control of our materials. If your glider should reach the point where it is no longer airworthy, please remove the metal parts. All other parts such as lines, cloth and risers can be brought to a waste disposal center. The metal parts can be brought to metal recycling. If you wish, you can send your glider on to us, and we will dispose of it in a responsible manner.

WEAR:

The skywalk MESCAL3 mainly consists of Nylon fabric ages strength and shows an increase in porosity under the influence of UV-radiation. Only unfold the paraglider shortly before starting and pack away immediately after landing to avoid any unnecessary sun exposure.

LINE-REPAIRS:

The lines of the skywalk MESCAL3 consist of a Tecnora- or Dyneema-core and a Polyester-cover. Avoid heavy loads on single lines, as excessive stretch may be irreversible. Repeated folding or kinking of lines at the same spot reduces their strength even if it's just a little.

Any visual damage of a line, even if it is only the line coating, requires a replacement. Only acquire new lines from the manufacturer or from an authorised skywalk-Service-Centre. Your flying school or your dealer will assist you to change a defective line. Check the correct length of the line before replacing it. Compare with its counterpart on the opposite side of your glider. After the exchange a line-check will be necessary. The best way to this is by unfolding the glider on the ground!

GENERAL INFORMATION:

- > When unfolding the paraglider insure that neither the canopy nor the lines become dirty as dirt particles in the fibres can damage the material and lines.
- > If the lines get tangled on the ground they may be over-stretched or break during take-off.
- > Do not step on the lines and/or canopy.
- > Make sure that no sand, stones or snow get inside the canopy as the extra weight collected in the trailing edge may slow down or even stall the glider.
- > Sharp edges damage the canopy.
- > Uncontrolled inflation attempts in strong winds may result in the glider impacting into the ground at high speed.
- > This can cause rips, damage on lines and/or fabric.
- > Make sure not to land your canopy leading edge first as this may cause permanent damage to this area of your paraglider.
- > After landings in trees or on water you should check the length of the lines.
- > After contact with salt water thoroughly rinse the equipment with fresh water!

12 2-YEAR-CHECK / CERTIFICATION

According to LTF regulations your glider will have to undergo a maintenance check after 24 months. According to these regulations the Two-Year-Check has to be carried out by the manufacturer, its representative or by the owner himself. The check will have to be confirmed by a official stamp (ex. Checkair label). Missing this deadline or if the check is carried out by an unauthorised company will lead to immediate loss of your skywalk MESCAL3 model certification and all warranty and liability claims. We recommend not doing this check yourself. Without the proper instruments and specific knowledge the check will be insufficient and the airworthiness of your glider cannot be guaranteed.

CHANGES TO THE PARAGLIDER:

Your skywalk MESCAL3 is manufactured within the regulated parameters of tolerance. These parameters are very narrow and must not be altered under any circumstance. Only this way the optimum balance between performance, handling and safety can be guaranteed!

UNAUTHORISED CHANGES CAUSE AN IMMEDIATE EXPIRATION OF THE OPERATING LICENSE! ANY LIABILITY CLAIM TOWARDS THE MANUFACTURER AND ITS DEALERS IS EXCLUDED!

13 CERTIFICATION

The MESCAL3 has LTF/EN A Homologation. The many homologation tests are the last hurdle in the development of a skywalk paraglider. The homologation test flights only take place when the test team is completely happy with the glider development. We remark that the certification results will differ during flight in thermals or turbulent air. The homologation informs solely regarding the paraglider performance during extreme-flight-manoevres performed in stable air conditions. These extreme-flight-manoevres during the homologation process should thus not be over-valued.

14 NATURE AND ECOLOGICAL COMPATIBILITY

We have taken the first step towards ecological awareness with our nature-friendly sport. Especially with our mountain climbers who prefer to climb to the launch site. Nevertheless, we plan on continuing in the same vein. This means specifically: clean up your trash, stay on marked trails and don't cause unnecessary noise. Please help to maintain the balance of nature and to respect animals in their territory.

15 CLOSING WORDS

Paragliding is a fascinating sport. With the skywalk MESCAL3, you now have a glider which represents the very top of glider technology today. This glider will bring you years of enjoyment when you treat it with care. Respect for the challenges and dangers of flying is a pre-requisite for successful, awe-inspiring flights. Even the safest paraglider can be dangerous when you second-guess weather information or experience pilot error. Please be reminded that every airsport is potentially risky and that your safety largely depends upon your own level of awareness. We recommend that you fly with caution and to respect the legal requirements.

EACH PILOT FLYS AT HIS OWN RISK!

Your skywalk Team

16 LINE PLAN

The displayed line plan of the skywalk MESCAL3 is only for demonstration purposes of the line configuration. Plans for other sizes can be acquired via flight schools, importers or directly from skywalk.

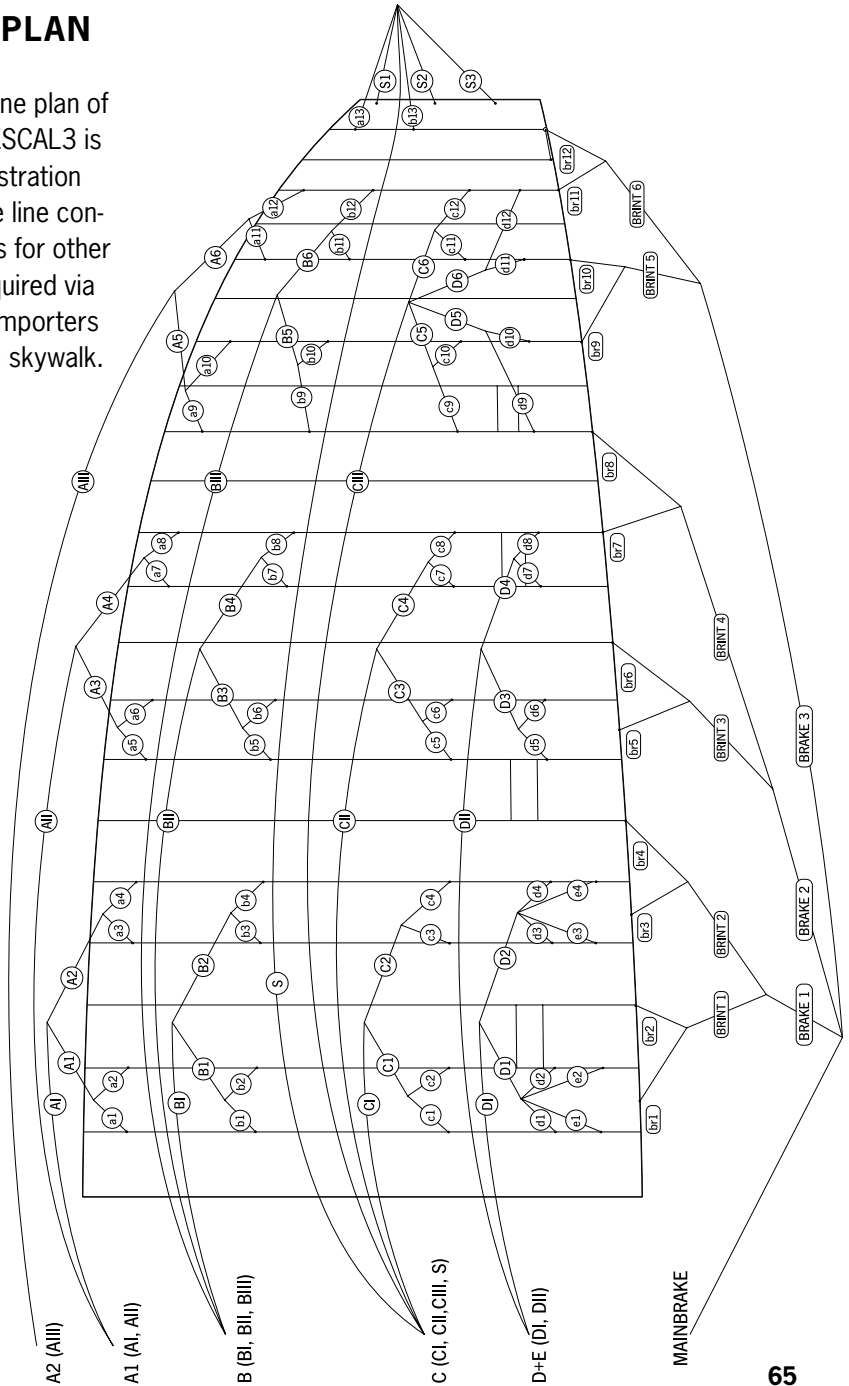

17 RISER

XS, S Size

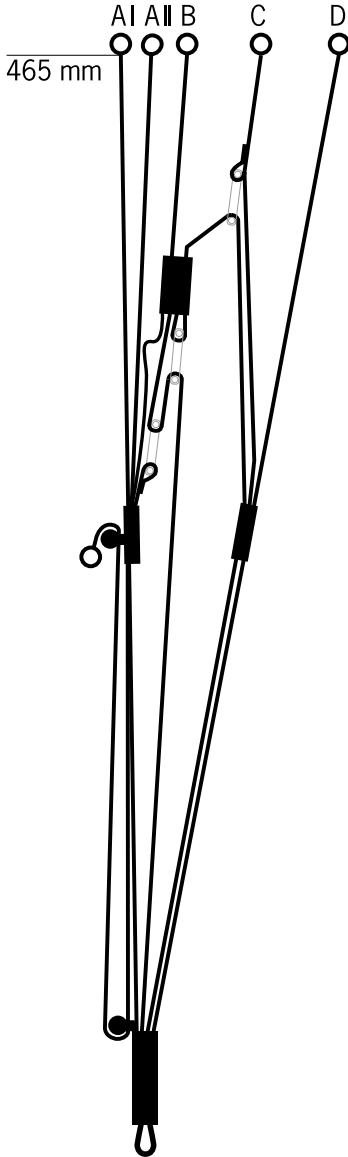

Trimspeed

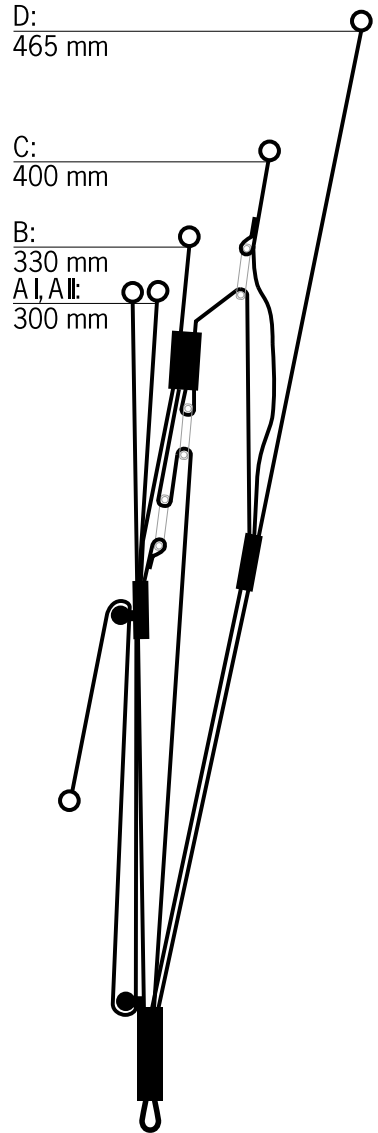

Accelerated

M Size

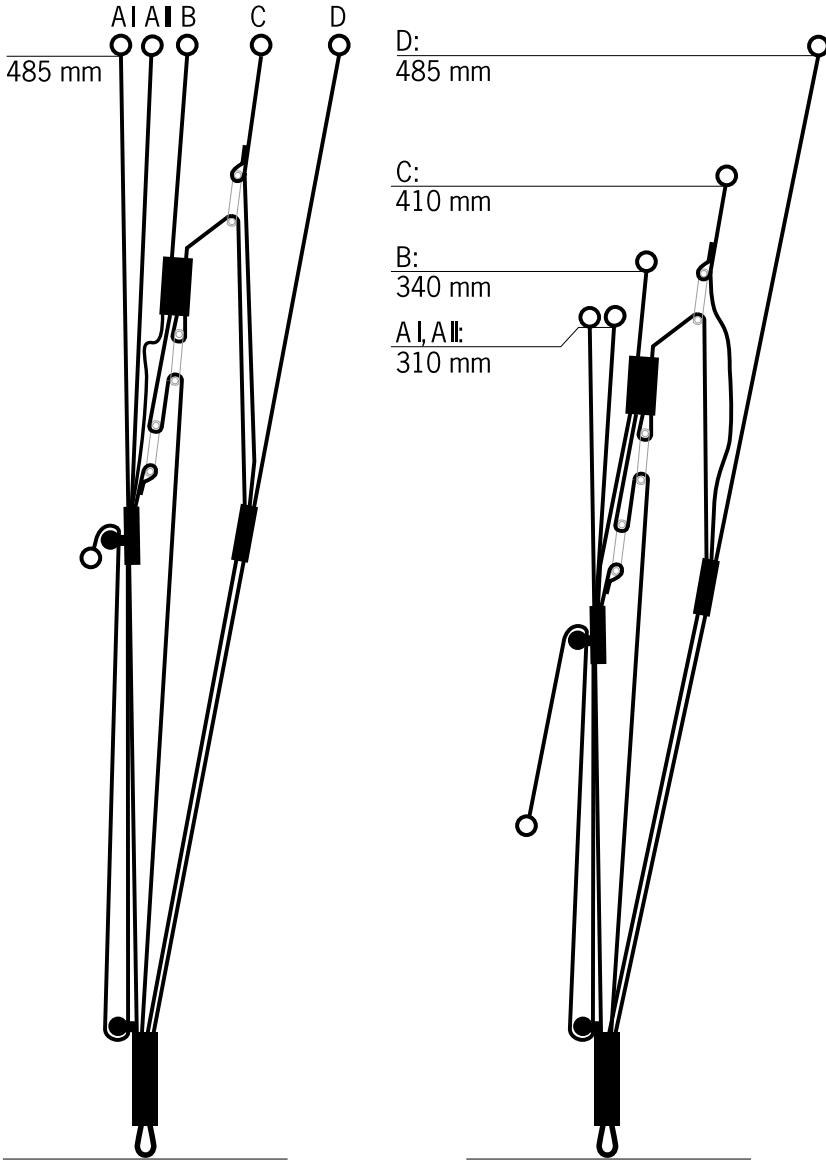

Trimspeed

Accelerated

17 RISER

L Size

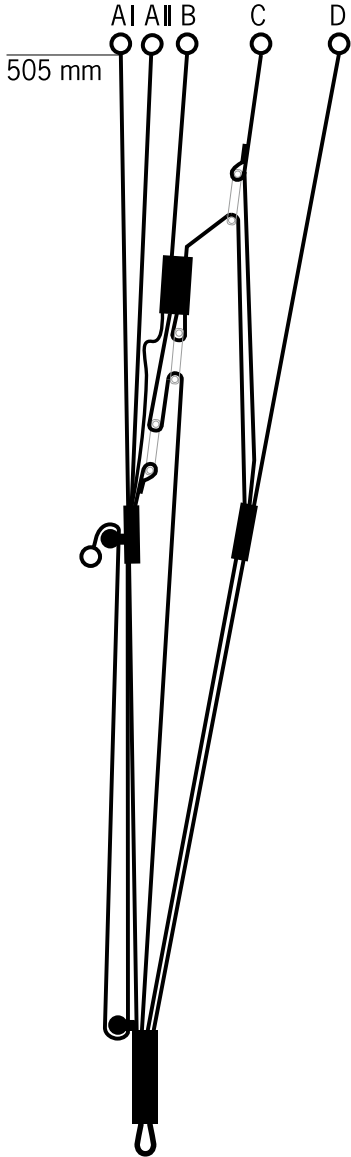

Trimspeed

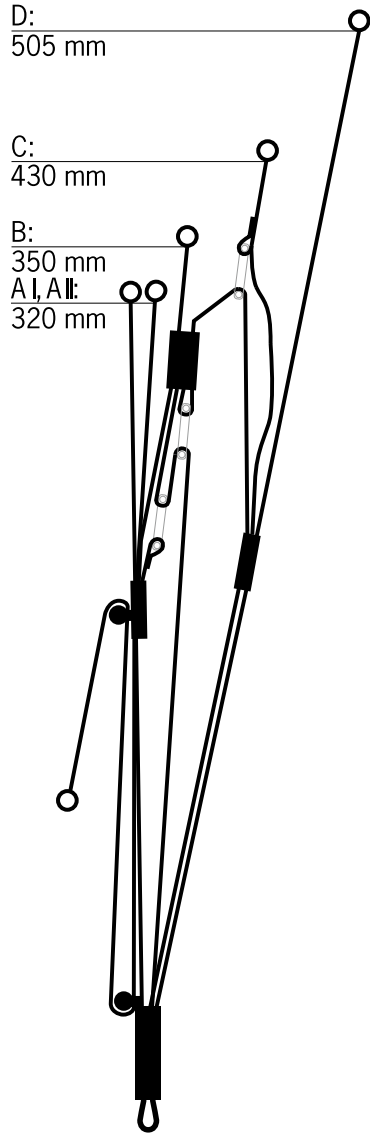

Accelerated

NOTES

18 TEST PROTOCOL

Test Protocol		Date:
Customer, Name:		
Adress:		Phone:
Glider:	Size:	Serial number:
Gütesiegelnr.	Date of last check:	
Date of first flight:	Year of construction:	

Accomplished checking:	Results: [+/-]	Description of failure	Suggested repairs
Identification:	<input type="checkbox"/> + <input type="checkbox"/> -		
Visual check of canopy:			
Upper surface:	<input type="checkbox"/> + <input type="checkbox"/> -		
Lower surface:	<input type="checkbox"/> + <input type="checkbox"/> -		
Profiles:	<input type="checkbox"/> + <input type="checkbox"/> -		
Line flares:	<input type="checkbox"/> + <input type="checkbox"/> -		
Leading edge:	<input type="checkbox"/> + <input type="checkbox"/> -		
Trailing edge:	<input type="checkbox"/> + <input type="checkbox"/> -		
Crossports:	<input type="checkbox"/> + <input type="checkbox"/> -		
Visual check of lines:			
Seams:	<input type="checkbox"/> + <input type="checkbox"/> -		
Abrasion spots:	<input type="checkbox"/> + <input type="checkbox"/> -		
Core withdrawals:	<input type="checkbox"/> + <input type="checkbox"/> -		
Vis. check of connectionparts:			
Suspension line screw locks:	<input type="checkbox"/> + <input type="checkbox"/> -		
Risers:	<input type="checkbox"/> + <input type="checkbox"/> -		
Length measurement:			
Risers:	<input type="checkbox"/> + <input type="checkbox"/> -		
Lines:	<input type="checkbox"/> + <input type="checkbox"/> -		
Examinations of the canopy:			
Firmness of canopy:	<input type="checkbox"/> + <input type="checkbox"/> -		
Porosity:	<input type="checkbox"/> + <input type="checkbox"/> -		

Examinations of the lines:			
Firmness of main lines:		<input type="checkbox"/>	<input type="checkbox"/>
		<input type="checkbox"/>	<input type="checkbox"/>
		<input type="checkbox"/>	daN
Visual check of trimming:	<input type="checkbox"/> +	<input type="checkbox"/> -	
Checkflight necessary?	<input type="checkbox"/> +	<input type="checkbox"/> -	
Gütesiegel patch?	<input type="checkbox"/> +	<input type="checkbox"/> -	
Identification plate?	<input type="checkbox"/> +	<input type="checkbox"/> -	
<p>Condition:</p> <p><input type="checkbox"/> New</p> <p><input type="checkbox"/> Very good condition</p> <p><input type="checkbox"/> Good condition</p> <p><input type="checkbox"/> Well used</p> <p><input type="checkbox"/> Heavily used, but within gütesiegel standards, frequent checks required</p> <p><input type="checkbox"/> No longer airworthy, outside of the limit values.</p>			
Repairs made?			
Signature of tester:		Date:	
Name of tester:		Firm stamp:	

SKYWALK

GmbH & Co. KG

Bahnhofstraße 110
83224 GRASSAU
GERMANY

Fon: +49 (0) 8641 - 69 48 40
Fax: +49 (0) 8641 - 69 48 11

www.skywalk.info
info@skywalk.info